

# User Manual

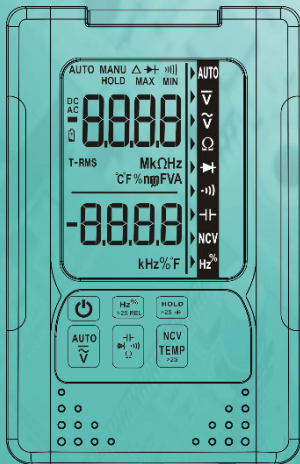

## LIMITED WARRANTY AND LIMITATION OF LIABILITY

Customers enjoy one-year warranty from the date of purchase.

This warranty does not cover fuses, disposable batteries, damage from misuse accident, neglect, alteration, contamination, or abnormal conditions of operation or handling, including failures caused by use outside of the product's specifications, or normal wear and tear of mechanical components.

# Contents

## Title Page

Instruction.....	1
Safety Information.....	1
Instrument Overview.....	3
LCD Display.....	3
Function Buttons.....	5
Measurement Instruction.....	7
Measure AC/DC Voltage.....	7
Measure Resistance.....	7
Test Continuity.....	8
Test Diodes.....	8
Measure Capacitance.....	9
Measure Frequency/Duty Cycle.....	10
NCV Test.....	10

Maintenance.....	11
Clean the Product.....	11
Replace the Batteries.....	11
Specifications.....	13
General Specifications.....	13
Mechanical Specifications.....	13
Environmental Specifications.....	14
Electrical Specifications.....	15

## Introduction

This product is a battery-powered, true RMS, auto-range multi-function digital multimeter with 6000 counts LCD display and adjustable backlight brightness.

## Safety Information

To avoid possible electrical shock, fire, or personal injury, please read all safety information before you use the product. Please use the product only as specified, or the protection supplied by the product can be compromised.

- Examine the case before you use the product. Look for cracks or missing plastic. Carefully look at the insulation around the terminals.
- The measurement must be made with correct input terminals and functions and within the allowable measuring range.



- Do not use the product around explosive gas, vapor, or in damp or wet environments.
- Keep fingers behind the finger guards on the probes.
- When the product has already been connected to the line being measured, do NOT touch the input terminal that is not in service.
- Disconnect the test leads from the circuit before changing the mode.
- When the voltage to be measured exceeds 36V DC or 25V AC, the operator shall be careful enough to avoid electric shock.
- Misuse of mode or range can lead to hazards, be cautious. "OL" will be shown on the display when the input is out of range.
- Low level of a battery will result in incorrect readings. Change the batteries when battery level is low. Do not make measurements when the battery door is not properly placed.

# Instrument Overview

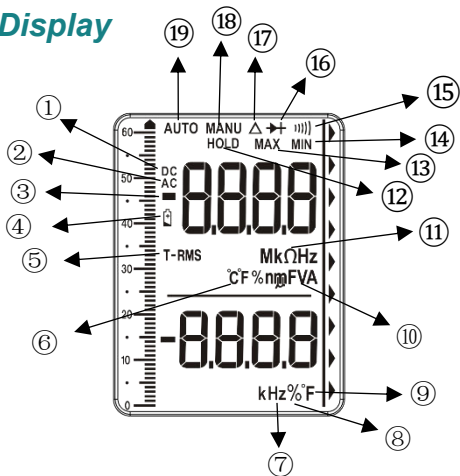
## LCD Display



①	<b>DC</b>	DC voltage
②	<b>AC</b>	AC voltage
③	<b>■</b>	Negative display
④	<b>+</b>	Low battery. Replace batteries.
⑤	<b>T-RMS</b>	True RMS
⑥	<b>°C °F</b>	Temperature test. (Fahrenheit or Celsius)

⑦	<b>Hz</b>	Frequency test. (Hertz)
⑧	<b>%</b>	Duty cycle
⑨	<b>F</b>	Capacitance test (Farad)
⑩	<b>V</b>	Voltage test (volt)
⑪	<b>Ω</b>	Resistance test (ohm)
⑫	<b>HOLD</b>	Data hold
⑬	<b>MAX</b>	Display shows maximum reading
⑭	<b>MIN</b>	Display shows minimum reading
⑮		Continuity test
⑯		Diode test
⑰		Display shows minimum reading.
⑱	<b>MANU</b>	Manual range
⑲	<b>AUTO</b>	Auto test
	<b>n k M μ m</b>	Test unit



## Function Buttons

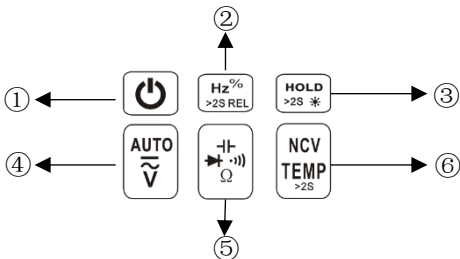

Long press to turn on/off the product.

- ①
- The product automatically powers off after 15 minutes of inactivity.
  - The built-in beeper beeps 5 times 1 minute before auto power off.
  - To restart the product from auto power off, press the SELECT button or turn the rotary switch back to the OFF position and then to a needed position.
  - To disable the Auto Power Off function, hold down the SELECT button when turning on the product, you will hear five beeps if you have successfully disabled the function.

② Press this button, the main display will show current frequency and the vice display will show the duty cycle. Press it again to quit. On capacitance, long press to clear the readings.

③	Push once to hold the current reading on the display; push again to continue normal operation. Long press more than 2s to turn on backlight, long press again to turn off it.
④	Press this button to enter in DC voltage function, press it to switch in DC and AC voltage. When test AC voltage, vice display will show frequency. When test DC voltage, vice display will show regular temperature. Long press temperature button to switch in Celsius and Fahrenheit.
⑤	Push this button to toggle between testing modes of Resistance, Diode/Continuity, and Capacitance. Vice display will show regular temperature , now long press temperature button to switch in Celsius and Fahrenheit .
⑥	Short press to enter in NCV test function, then press again to turn it off. Long press to switch temperature unit in °C/°F.

# Measurements Instruction

## Measure AC/DC Voltage

1. Press the  button to enter voltage test, short press to choose AC or DC Voltage range. Now, vice display will show frequency when on AC mode; vice display will show regular temperature when on DC mode.
2. Touch the probes to the correct test points of the circuit to measure the voltage.
3. Read the measured voltage on the display.

- Do not measure voltage that exceeds the extremes as indicated in the Specifications.
- Do not touch high voltage circuit during measurements.

## Measure Resistance

1. Press  button once to switch to resistance range.
2. Use the probe pin to contact two sides of the resistance.
3. Read the measured resistance on the display.

- Disconnect circuit power and discharge all capacitors before you test resistance.
- Do not input voltage at this setting.

## Test for Continuity

1. Press  button three times to enter in continuity range.
2. Use the probe pin to contact two sides of the circuit.
3. The built-in beeper will beep when the resistance is lower than  $50\Omega$ , which indicates a short circuit.

**\*Do not input voltage at this setting.**

## Test Diodes

1. Press  twice to enter in diode range.
2. Contact the read pin with the positive pole and the black lead pin with the negative pole of the diode.
3. Read the forward bias voltage value on the display.

5. If the polarity of the test leads is reversed with diode polarity or the diode is broken, the display reading shows “OL”.

- Do not input voltage at this setting.

## Measure Capacitance

1. Press  button four times to enter in capacitance range.
2. Contact the read pin with the positive pole and the black lead pin with the negative pole of the diode.
3. Read the measured capacitance value on the display once the reading is stable.

- Do not input voltage at this setting.
- Disconnect circuit power and discharge all capacitors before you test diode.

## Measure frequency and duty cycle.

1. Press  to enter in frequency range (low voltage and high frequency), now the vice display will show duty cycle.
2. Touch the probes to the desired test points.
3. Read the measured frequency value on the display, read the duty cycle value at the vice display.

## Test NCV

1. Short press  to enter the NCV Mode, now the vice display will show regular temperature.
2. Hold the product and move it around, the built-in beeper will beep when the inner sensor detects AC voltage nearby. The stronger the voltage is, the quicker the beeper beeps.

## Maintenance

Beyond replacing batteries and fuses, do not attempt to repair or service the product unless you are qualified to do so and have the relevant calibration, performance test, and service instructions.

### *Clean the Product*

Wipe the product with a damp cloth and mild detergent. Do not use abrasives or solvents. Dirt or moisture in the terminals can affect readings.

\*Remove the input signals before you clean the product.

### *Replace the Batteries*

When “” is shown on the display, batteries shall be replaced as below:

1. Remove the test leads and turn off the product before replacing the batteries.

2. Loosen the screw on the battery door and remove the battery door.
3. Replace the used batteries with new batteries of the same type.
4. Place the battery door back and fasten the screw.



## Specifications

<b>General Specifications</b>	
Display ( LCD )	6000 counts
Ranging	Auto
Material	ABS+TPE
Update rate	3 times/ second
True RMS	√
Data hold	√
Backlight	√
Low battery Indicated	√
Auto power off	√
<b>Mechanical Specifications</b>	
Dimension	125*81*23mm
Weight	170g (without battery)
Battery type	1.5V AAA battery * 2
Warrantly	One year

### ***Environmental Specifications***

Operating	Temperature	0~40°C
	Humidity	<75%
Storage	Temperature	-20~60°C
	Humidity	<80%

## Electrical Specifications

<i>Function</i>	<i>Range</i>	<i>Resolution</i>	<i>Accuracy</i>
<i>DC voltage (V)</i>	6.000V	0.001V	$\pm(0.5\%+3)$
	60.00V	0.01V	
	600.0V	0.1V	
<i>AC voltage (V)</i>	6.000V	0.001V	$\pm(1.0\%+3)$
	60.00V	0.01V	
	600.0V	0.1V	

Function	Rnage	Resolution	Accuracy
Resistance	600.0Ω	0.1Ω	±(0.5%+3)
	6.000kΩ	0.001kΩ	
	60.00kΩ	0.01kΩ	
	600.0kΩ	0.1kΩ	
	6.000MΩ	0.001MΩ	
	60.00MΩ	0.01MΩ	±(1.5%+3)
Capacitance	6.000nF	0.001nF	±(5.0%+20)
	60.00nF	0.01nF	±(3.5%+4)
	600.0nF	0.1nF	
	6.000μF	0.001μF	
	60.00μF	0.01μF	
	600.0μF	0.1μF	
	6.000mF	0.001mF	±(5.0%+5)
	60.00mF	0.01mF	

Function	Range	Resolution	Accuracy
Frequency	6.000Hz	0.001Hz	$\pm(0.1\%+5)$
	60.00Hz	0.01Hz	
	600.0Hz	0.1Hz	
	60.00kHz	0.01kHz	
	600.0kHz	0.1kHz	
	6.000MHz	0.001MHz	
	10.00MHz	0.01MHz	
Duty cycle	1%~99%	0.1%	$\pm(0.1\%+2)$
Temperature	Regular temperature		
Diode	√		
Continuity	√		

